

TUNNELPROFILER FOR NORMALT SPOR KLI OG KL.II

M. 1:100.

Retlinie.

R=500-1000m.

R=250-499.

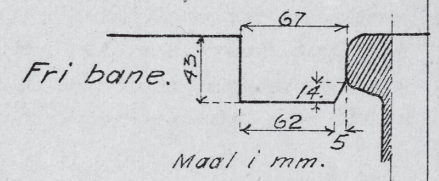
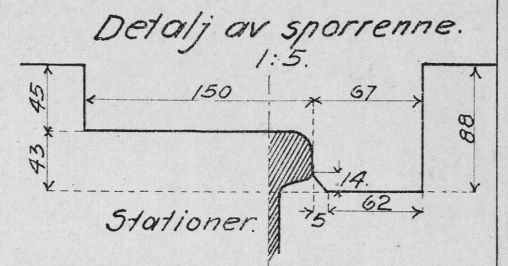
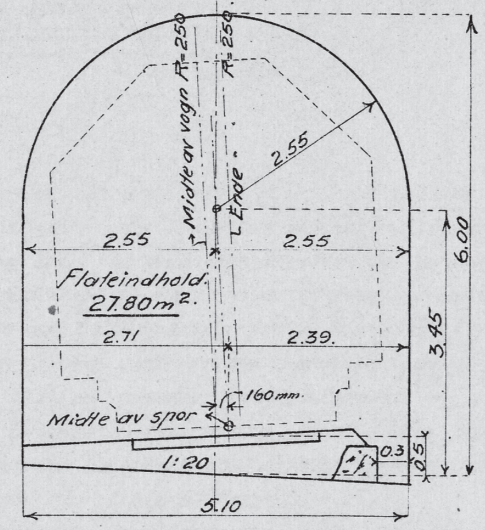
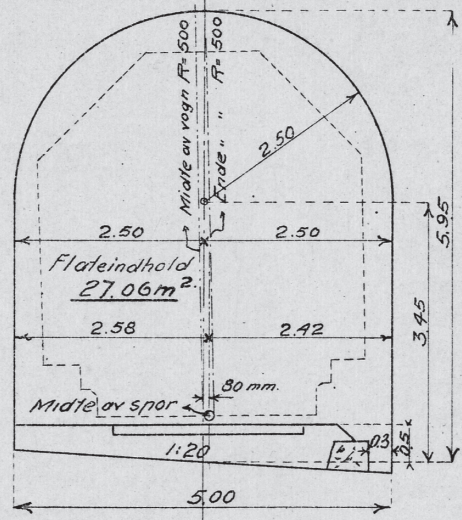
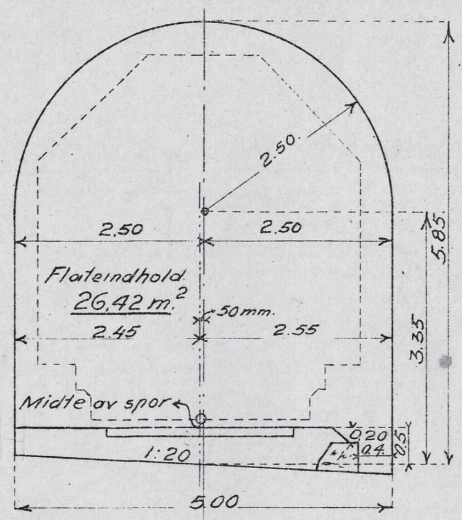

Anm.
Ved sporveksler (ledeskinner og krossinger) kan sporrennens bredde indskrænkes fra 67mm. til 40mm.
Længde av boggielvogn = 25m.
Avstand mellem boggiel = 19m.

Efter N.N. N^o. 271 og 272.

NORMALPROFILER FOR BREDSPORTE BANER KL.II

(Se ogsaa side 14.)

Støttemur.

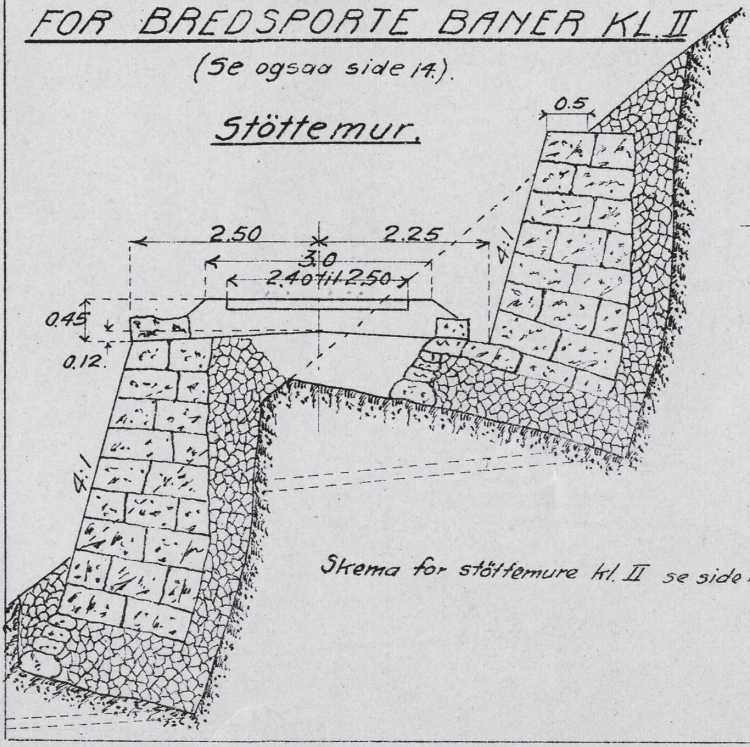

Skema for støttemure kl. II se side 11.

Fylding paa myr.

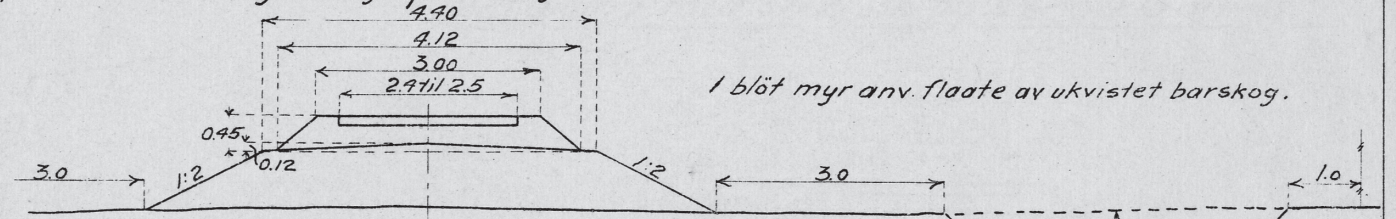

Skjæring i myr.

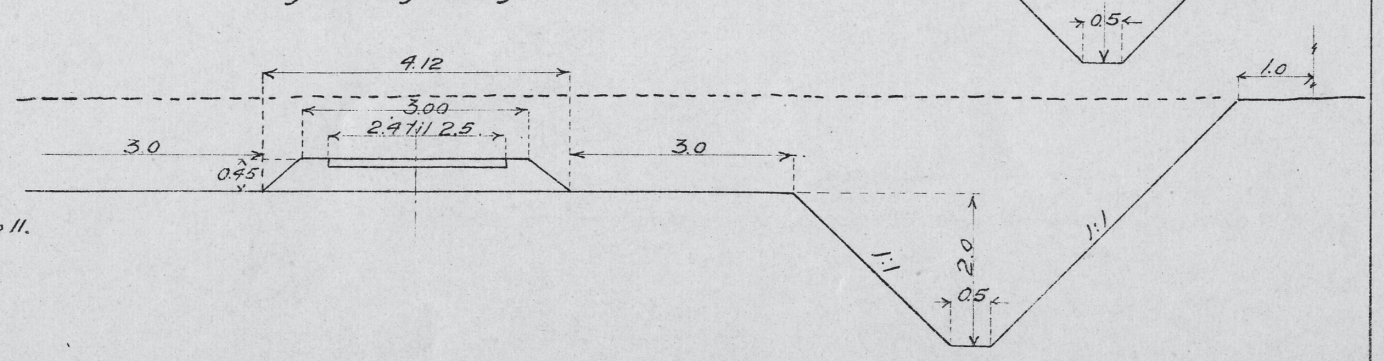

Efter N.N. N^o 272.